

Absender / Firmenstempel | Sender / Company stamp
Expéditeur / cachet de société | Mittente / Timbro della ditta:

Ansprechpartner | Contact | Responsable | Interlocutore:

Grosshandel | Wholesaler | Grossiste | Grossista:

Kommission | Commission | Commissione:

Auftrags Nr. | Order No. | Ordre No. | N°. d'ordine

Glas Nr. | Glass No. | Verre No. | Vetro N°: _____

Farbe Nr. | Colour No. | Couleur No. | Colore N°: _____

Handtuchhalter | Towel-Rack | Porte serviette | Portasciugamani:

Länge | Length | Longueur | Lungo _____

Einbauhöhe | Fixing height | Hauteur de fixation |
Altezza di fissaggio: _____ mm

mm

Traverse | Stabilising bar | Traversa | Traversa

Nein | No | Non | No Ja | Yes | Oui | Si

Bereits montiert | already fitted | déjà fixé | già montato

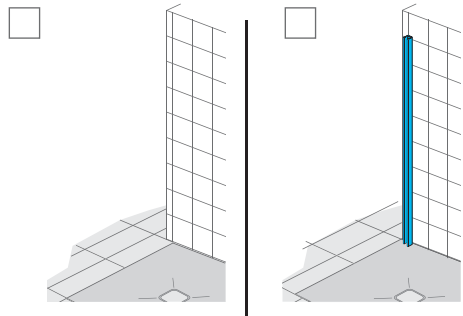

Bitte um Kostenvoranschlag gemäss Angaben
Send me an offer according the specifications
Demande d'offre selon données ci-dessus
Di farmi un preventivo-rispetto a questo box doccia

Diese Vorlage gilt bereits als Auftrag
Ordering according the mentioned specifications
Commande selon données ci-dessus
Questo progetto e valido come ordine

Datum | Date | Date | Data: _____

Unterschrift | Signature | Signature | Firma

Masse (in mm) hier eintragen
Here to put down measures (in mm)
Indiquez ici les mesures (en mm)
Inserire le misure (in mm)

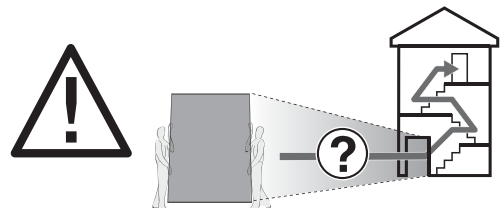
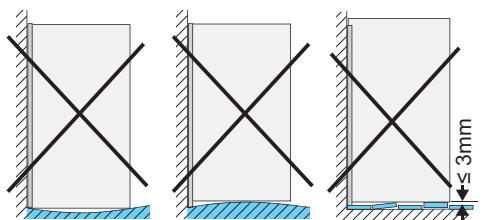
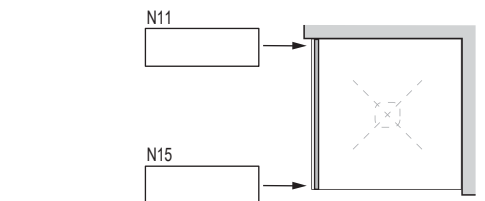
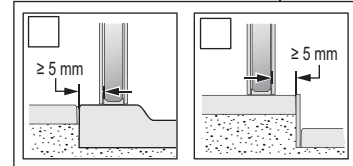
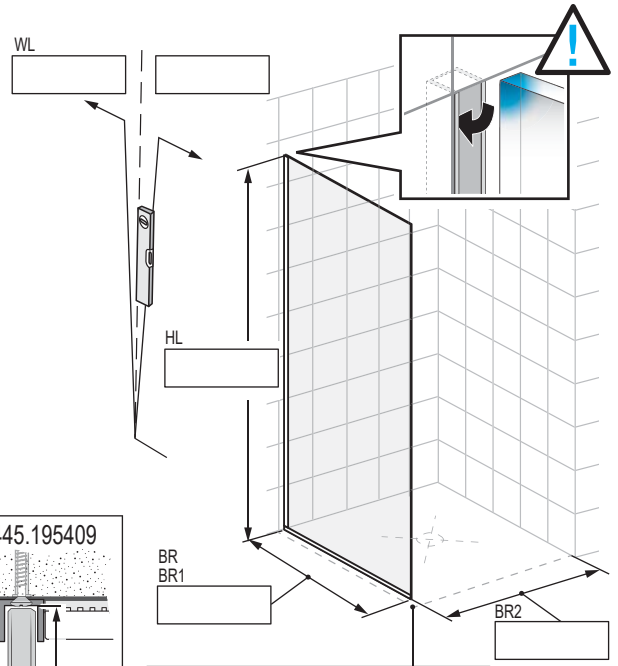
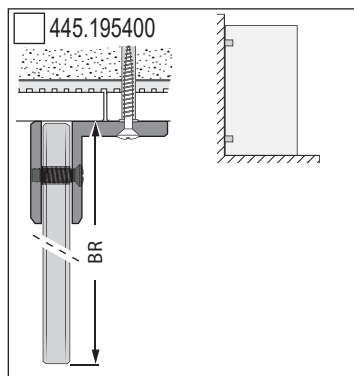
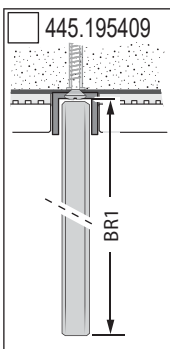
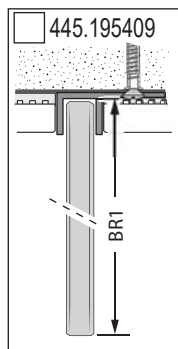
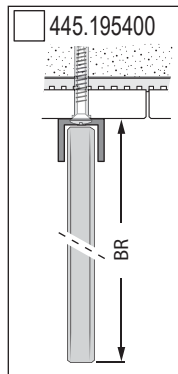

Platz für weitere Informationen
Place for further information
Place pour informations supplémentaires
Spazio per altre informazioni